



BRUGNOTTO® SHOP INTERIORS



BRUGNOTTO SHOP INTERIORS produce sistemi di arredi modulari per negozi e spazi espositivi.

L'azienda è stata fondata nel 1980 e ha sede nel nord est d'Italia, a 40 km dalla città di Venezia.

Nei suoi stabilimenti di 18.000 mq, sono presenti le più moderne tecnologie produttive ed operano abili professionisti e designers con grande esperienza nel fashion retail design.

BRUGNOTTO SHOP INTERIORS offre soluzioni di arredo innovativo per nuovi spazi commerciali, grazie anche alla capacità di abbinare più materiali, quali vere pelli selezionate, ecopelle stampata e verniciata, metalli e legni con particolari finiture.

Tutti questi materiali vengono lavorati all'interno dell'azienda con cura e sapienza artigianale rendendo BRUGNOTTO SHOP INTERIORS una realtà unica ed esclusiva.

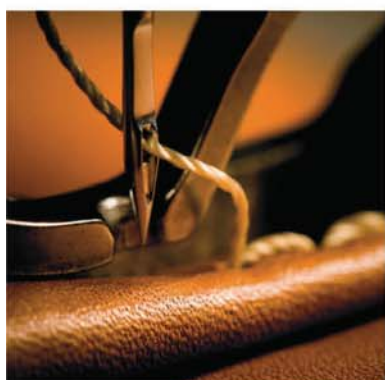

BRUGNOTTO SHOP INTERIORS produces modular pieces of furniture for shops and show spaces.

The company was founded in 1980 with its headquarters in northeastern Italy, 40 kilometres from Venice.

Its headquarters is comprised of 18.000 square metres where the most up-to-date production technology is used by designers and professionals who have a vast experience in modern retail design.

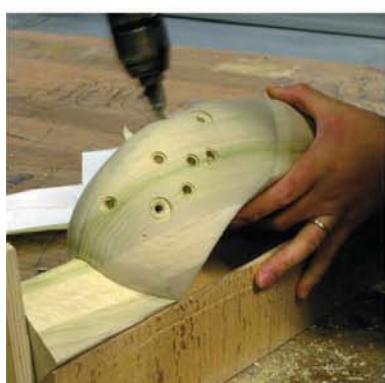

BRUGNOTTO SHOP INTERIORS is able to find innovative furnishing solutions for new commercial spaces thanks to the ability of using different materials, such as carefully chosen genuine leather, printed and varnished eco-leather, various different metals and types of wood with particular finishings.

All these specified materials are used within the company using great care and specialist knowledge making BRUGNOTTO SHOP INTERIORS completely unique and exclusive.

DA+DO[®]

Eugenio Ferrante
project



BREVETTATO
PATENTED

DA+DO

Sistema di arredo universale, composto da un elemento declinato in tre multipli di misura, liberamente componibile. Caratterizzato da una forma (brevettata) che ne permette la libera retroilluminazione è inoltre accompagnato da un set di accessori che lo rende adatto e personalizzabile ad ogni esigenza.

DA+DO

Universal furniture system, based on one element available in three multiple sizes, afterwards it's totally free stackable. It's defined by a shape (patented) that allows to backlight it without limitations, it's also associated with accessories that make it suitable and customizable for every requirement.



DA+DO si presta a soddisfare qualsiasi esigenza:
esporre, contenere, ordinare, arredare, grazie alla sua semplicità e compatibilità
di finiture, accessori ed alla libertà di composizione che offre.
Funzionale e discreto, mutevole e rigoroso.
DA+DO è adatto a piccole e grandi composizioni, in self standing o coordinate.

*DA + DO can satisfy all your needs:
exhibit, contain, order, furnishing, thanks to its simplicity and compatibility of finishes,
accessories and compositional freedom it offers.
Functional and unobtrusive, changing and rigorous.
DA+DO is suitable for small and large compositions, self-standing or coordinated.*



ASSEMBLAGGIO ELEMENTO
ELEMENT ASSEMBLY

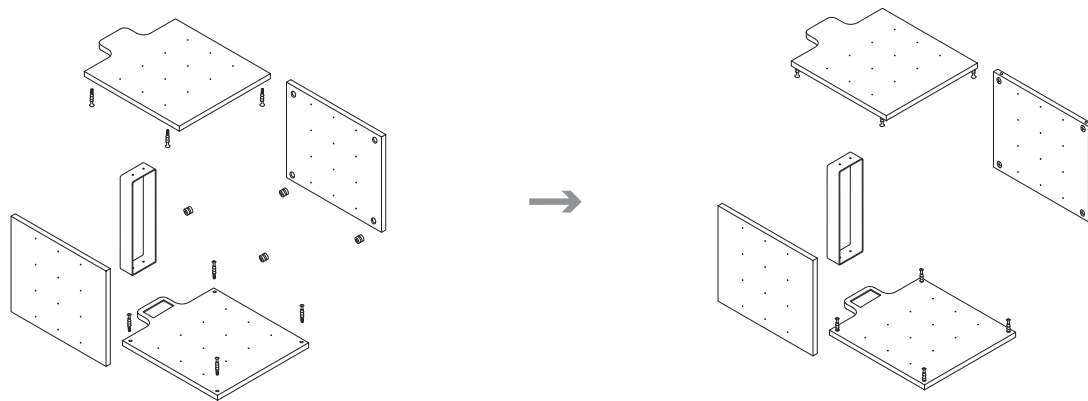

ALLESTIMENTO BASE IN METALLO
METAL BASEMENT FITTING

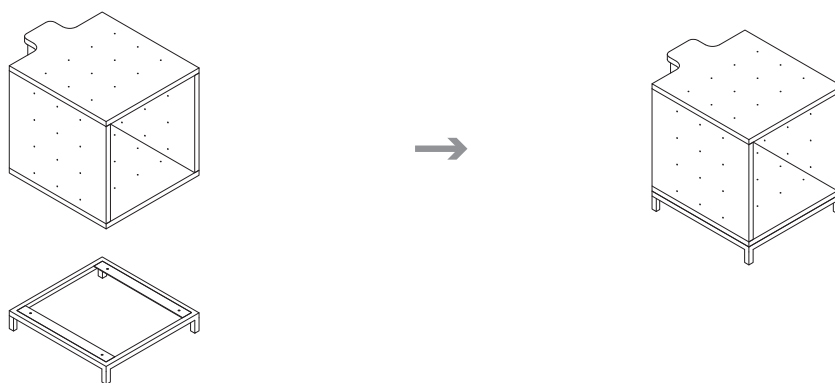

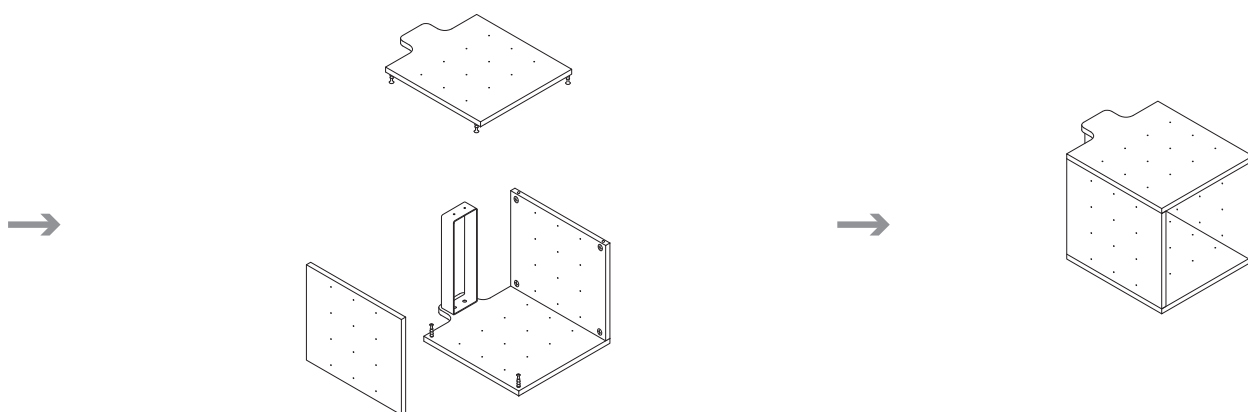

La semplicità è il punto focale del sistema DA+DO.

Ogni elemento è composto da quattro pannelli e una staffa in metallo, assemblati secondo la più classica e semplice delle metodologie : eccentrici e rispettivi perni di fissaggio.

In quattro semplici passaggi ogni modulo DA+DO può essere assemblato e pronto all'uso, è possibile poi aggiungere uno o più accessori e creare la propria composizione tra i diversi moduli del sistema.

Simplicity is the system's focal point for DA+DO.

Each element is composed of four panels and a metal bracket, nothing more, assembled under the most classic and simple methods: eccentric & pins.

In four simple steps each module of DA+DO can be assembled and ready to use, with a further step you can add one or more accessories, or create your own composition between the different modules of the system.

VARIANTI DIMENSIONI ELEMENTI ELEMENT'S SIZES VARIATIONS

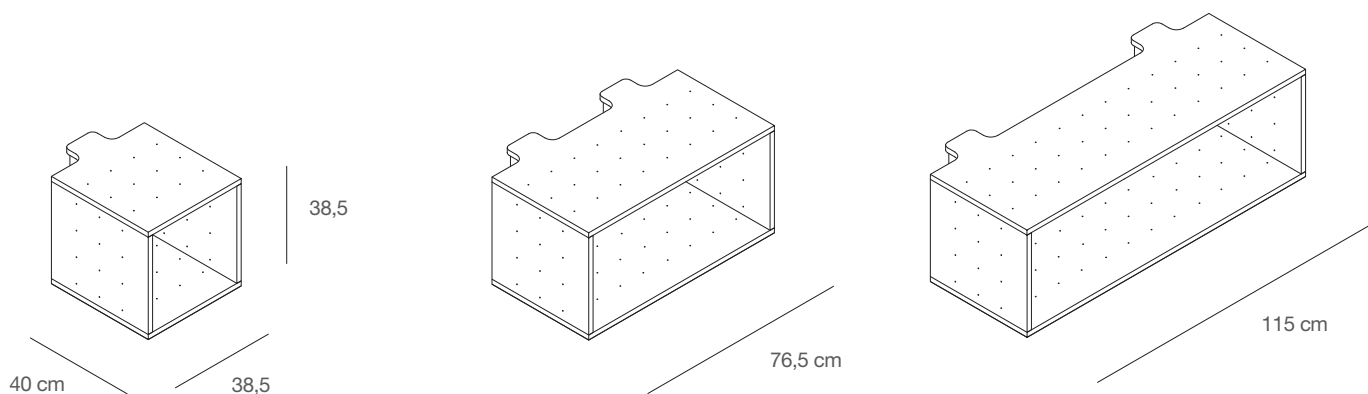



La composizione possibile totalmente libera del DA+DO lo rende sistema di arredo "infinito". I moduli vengono fissati con semplici e comuni "viti a cannocchiale", facendo combaciare uno o più fori presenti su uno dei lati di ogni singolo modulo. E' possibile così collegare moduli in senso orizzontale e verticale. La presenza di una matrice a tre righe di fori permette inoltre di disassare il rapporto tra i moduli, sia verticalmente che orizzontalmente; qualora si volesse creare un rapporto più "disordinato" tra i moduli, è possibile fissarli in un solo punto, permettendo la rotazione sul piano orizzontale.

The completely free available composition of the DA+DO makes this furniture system "infinite". The modules are fixed together with simple and common "telescope screw", matching one or more holes on the sides of each module. So you can connect modules in horizontal and vertical ways, the presence of a three rows array holes also allows you to offset the position between the modules, both vertically and horizontally, and if you want to create a more "messy" composition between the modules, you can fix them in one place, allowing the turning on the horizontal plane.

SISTEMA DI GIUNZIONE DEGLI ELEMENTI
ELEMENT'S JUNCTION SYSTEM

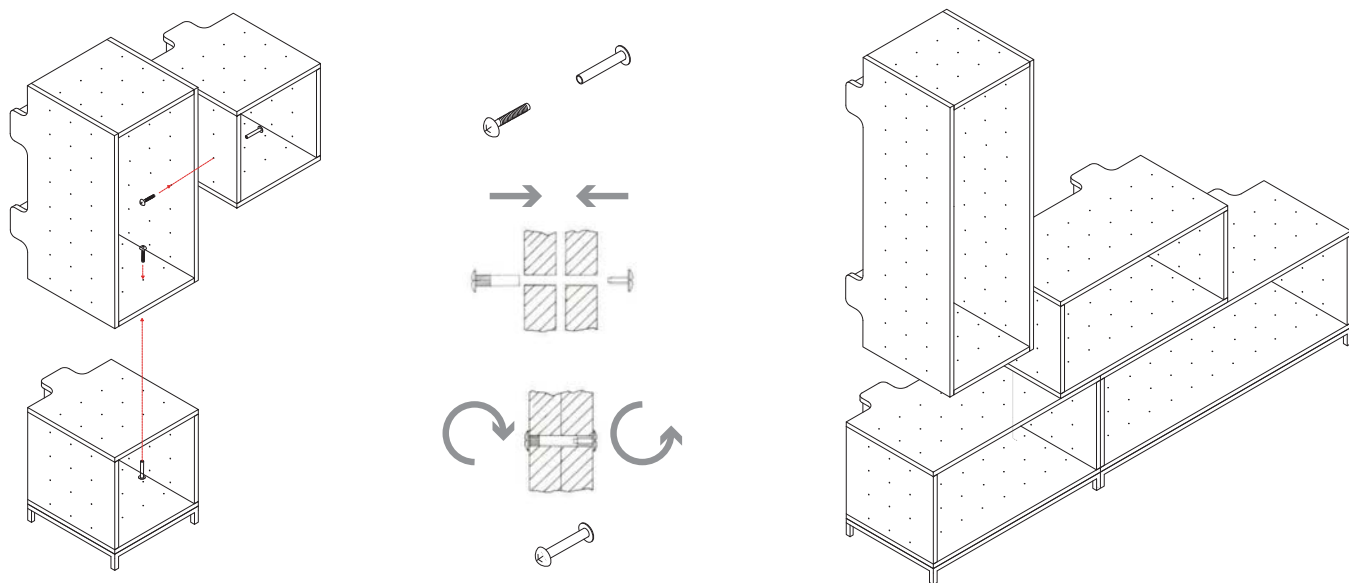



DIMENSIONI BASE IN METALLO DEGLI ELEMENTI
ELEMENT'S METAL BASEMENTS SIZES

Un telaio in acciaio grezzo verniciato trasparente disponibile in tre misure corrispondenti ai moduli di DA+DO consente di porre direttamente a terra gli elementi, come singoli, o come base di partenza per la propria composizione.

A raw steel transparent painted frame is available, in three sizes matchable with DA+DO modules. It allow you to place them directly on the floor as a single element, or to start your own composition.

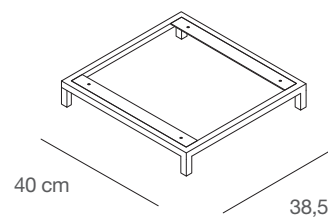

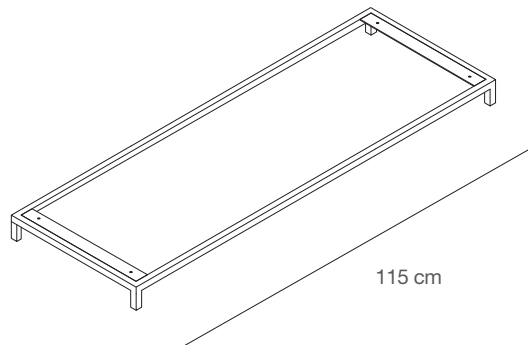
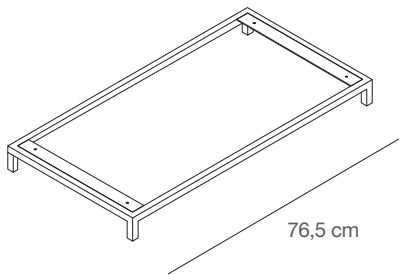



BARRA APPENDERIA
HANGING BAR

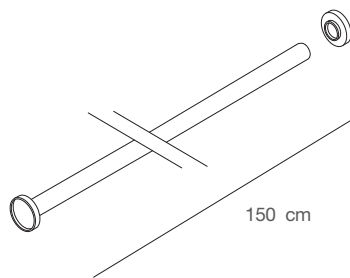

BARRA LED A TERRA WALL-WASH
FLOOR LED BAR WALL-WASH

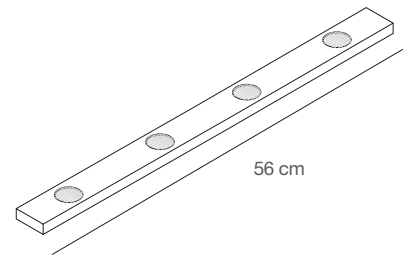

MENSOLA IN METALLO (REVERSIBILE)
METAL SHELF (REVERSIBLE)

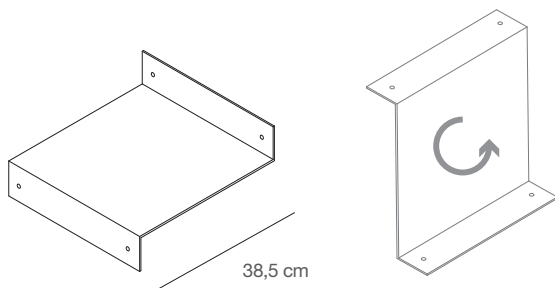

ANTE DOORS

La personalizzazione è il punto conclusivo della composizione.
La linea DA+DO comprende un range di accessori adatti ad ogni esigenza tra cui ante,
mensole, sistemi di illuminazione e piedini di supporto.

*Customization is the composition final checkpoint.
DA+DO includes a complete accessories range, just to make it suitable for
every requirement, doors, shelves, backlighting systems and basement frames.*

ANTE IN VETRO GLASS DOORS

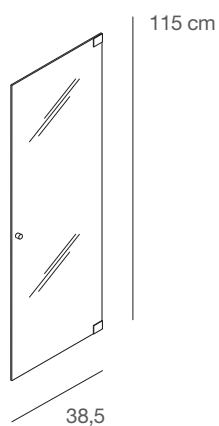
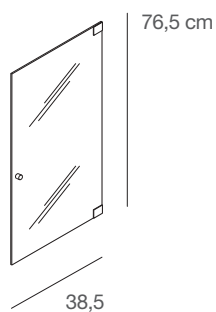
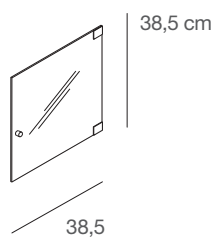

ANTE IN NOBILITATO FACED PANEL DOORS

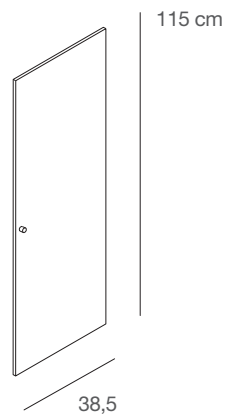
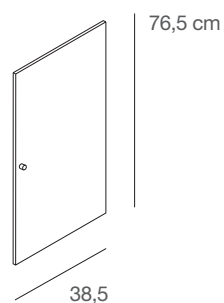
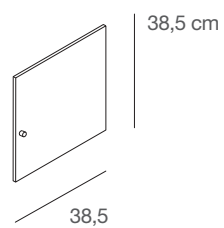



Per completare ed arricchire la propria composizione è disponibile una serie di pannelli modulari caratterizzati da una esclusiva finitura in laminato "vera pietra". Disponibili in 4 colori e varianti di trama, grazie al metodo di realizzazione, sono del tutto realistici e consentono di rivestire a piacere una parete con un effetto "pietra" totale.

To complete and enrich your composition is available a series of modular panels characterized by a unique laminate "real stone" finishing. Available in 4 colors and variations of the plot, due to the method of realization, are totally realistic and allows to coat a wall with a total "stone" effect.

MODULI PARETE "VERA PIETRA"
WALL ELEMENTS "REAL STONE"

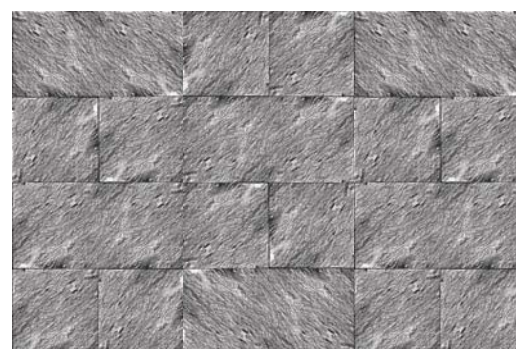
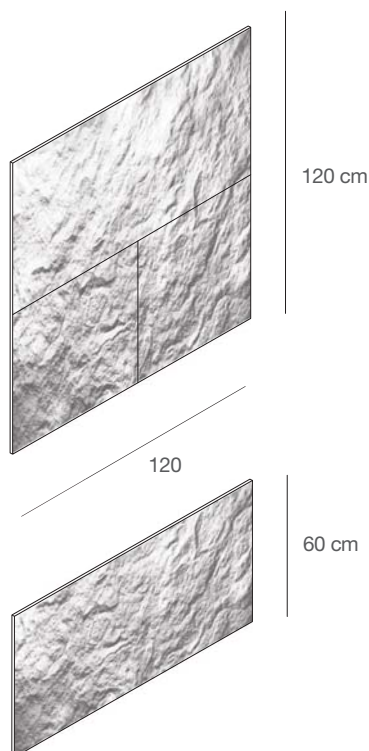

120 cm
ESEMPIO TEXTURE A PARETE COMPLETA
COMPLETE WALL TEXTURE EXAMPLE

La naturalezza e originalità delle finiture implica un certo grado di irregolarità nelle composizioni, caratteristica del materiale stesso.

The finishing's naturality and originality implies a certain degree of irregularities in the compositions, characteristic of the material itself.

FINITURE E MATERIALI
FINISHINGS AND MATERIALS

PANNELLI NOBILITATO
FACED PANELS



LAMIERA OSSIDATA
OXIDIZED SHEET



ROVERE TAVOLATO
PLANKING OAK

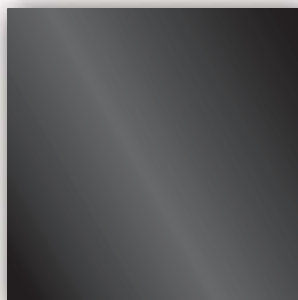

NERO LUCIDO
GLOSSY BLACK

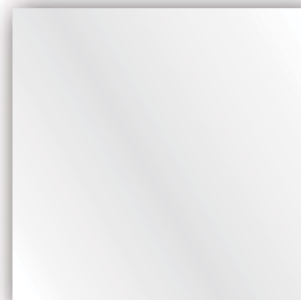

BIANCO LUCIDO
GLOSSY WHITE

ACCESSORI
ACCESSORIES



FERRO GREZZO
RAW IRON

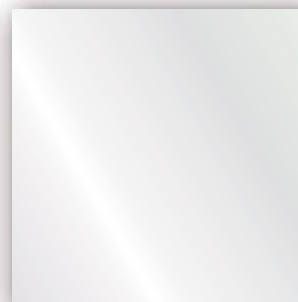

VETRO TRASPARENTE
CLEAR GLASS

FINITURE E MATERIALI "VERA PIETRA"
FINISHINGS AND MATERIALS "REAL STONE"



ARGENTO



COBRE NEW



AURO



D_BLACK

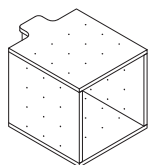

DA-1/L
Elemento DA+DO nobilitato lucido
DA+DO element in glossy faced panel
L. 38,5 x P. 40 x H. 40 cm

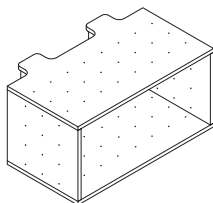

DA-2/L
Elemento DA+DO nobilitato lucido
DA+DO element in glossy faced panel
L. 76,5 x P. 40 x H. 40 cm

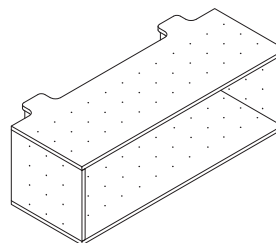

DA-3/L
Elemento DA+DO nobilitato lucido
DA+DO element in glossy faced panel
L. 115 x P. 40 x H. 40 cm

DA-1/N

Elemento DA+DO nobilitato
DA+DO element in faced panel
L. 38,5 x P. 40 x H. 40 cm

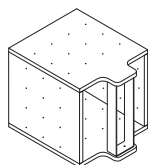

DA-2/N

Elemento DA+DO nobilitato
DA+DO element in faced panel
L. 76,5 x P. 40 x H. 40 cm

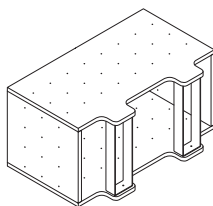

DA-3/N

Elemento DA+DO nobilitato
DA+DO element in faced panel
L. 115 x P. 40 x H. 40 cm

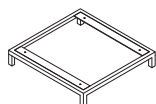
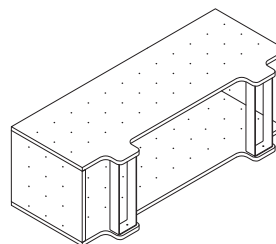

DA-BA1
Elemento base DA+DO in metallo
DA+DO element metal base
L. 38,5 x P. 40 x H. 7,5 cm

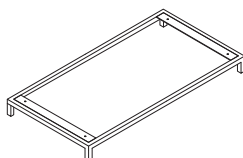

DA-BA2
Elemento base DA+DO in metallo
DA+DO element metal base
L. 76,5 x P. 40 x H. 7,5 cm

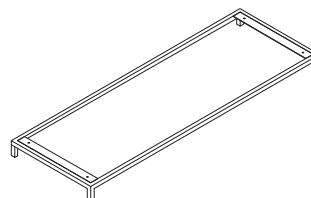

DA-BA3
Elemento base DA+DO in metallo
DA+DO element metal base
L. 115 x P. 40 x H. 7,5 cm

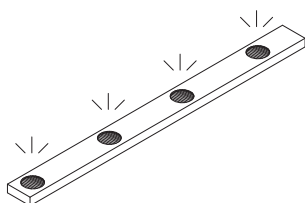

DA-LED
Elemento LED a terra luce wall-wash
LED floor light wall-wash
L. 56 x P. 3 x H. 2 cm

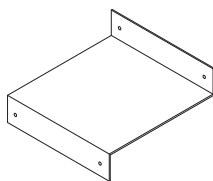

DA-ME
Elemento mensola in metallo
Shelf element in metal
L. 38 x P. 34,5

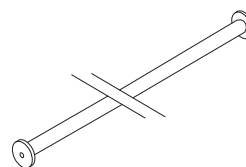

DA-BAP
Elemento barra appenderia
Hanging bar element
L. 150

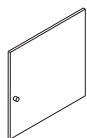

DA-ANL1/L
Anta in nobilitato lucido
Door in glossy faced panel
L. 38 x H. 38,5 cm

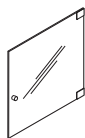

DA-ANV1
Anta in vetro
Glass door
L. 38 x H. 38,5 cm

DA-ANL1/N
Anta in nobilitato
Door in faced panel
L. 38 x H. 38,5

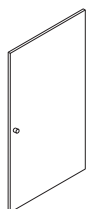

DA-ANL2/L
Anta in nobilitato lucido
Door in glossy faced panel
L. 38 x H. 76,5 cm

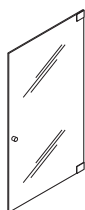

DA-ANV2
Anta in vetro
Glass door
L. 38 x H. 76,5 cm

DA-ANL2/N
Anta in nobilitato
Door in faced panel
L. 38 x H. 76,5

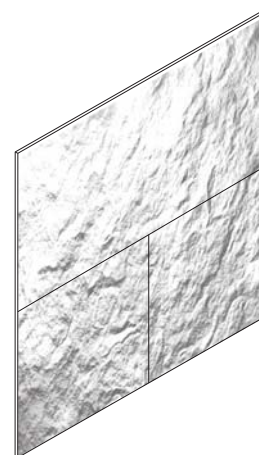

DA-PAN120
Pannello in laminato "Vera Pietra"
Wall panel "Real Stone Veneer"
L. 120 x H. 120 cm

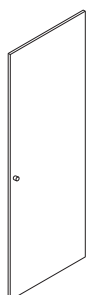

DA-ANL3/L
Anta in nobilitato lucido
Door in glossy faced panel
L. 38 x H. 115 cm



DA-ANV3
Anta in vetro
Glass door
L. 38 x H. 115 cm

DA-ANL3/N
Anta in nobilitato
Door in faced panel
L. 38 x H. 115

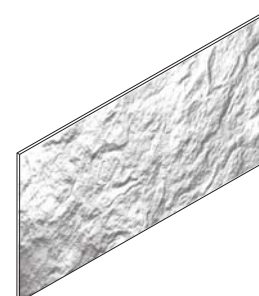

DA-PAN60
Pannello in laminato "Vera Pietra"
Wall panel "Real Stone Veneer"
L. 120 x H. 60 cm



MADE IN ITALY



CONDIZIONI GENERALI DI VENDITA

- La merce viene controllata prima della spedizione. Il vettore è il solo responsabile di eventuali danni. Spetta al cliente controllare la merce all'atto del ritiro e contestare subito al vettore le eventuali avarie e mancanze. Reclami non relativi al trasporto devono essere presentati entro 8 giorni dalla data di ricevimento della merce. Dopo tale termine la merce si intende integralmente accettata.
- La Brugnotto shop interiors si riserva di apportare variazioni tecniche, dimensionali, estetiche a materiali e prodotti.
- Non verranno accettati resi di merce se non preventivamente autorizzati per iscritto da Brugnotto shop interiors. Il reso sarà sempre spedito alla nostra sede franco ogni spesa e adeguatamente imballato nella scatola originale. Imballaggi inadeguati che comportino danni all'articolo, autorizzeranno Brugnotto shop interiors ad addebitare il costo.
- Per qualsiasi controversia il Foro competente sarà quello di Treviso.

GENERAL TERMS OF SALE

- *The goods are checked before any shipment. The carrier is the one responsible for any damage. It's up to the customer to check the goods upon collection and contest immediately the carrier for any lacking or damage.*
- *Brugnotto shop interiors reserves the right to bring any technical, size and aesthetical modifications to the products.*
- *Returned good will not be accepted unless previously authorized by Brugnotto shop interiors in writing by written letter. Returned goods must always be sent to our main offices free of all charges and properly pakaged in their original box. Improper boxing, resulting in damage to the item, will authorize Brugnotto shop interiors to charge its cost. The purchaser, under no circumstances, will have a claim on any type of compensation. Penalties may be taken into consideration only upon previous written agreements.*
- *Any dispute will be resolved at the place of jurisdiction of Treviso (Italy).*

BRUGNOTTO®
SHOP INTERIORS

Bjørn Haug AS
Oserødmyra 2
3138 SKALLESTAD
Tlf: 33 29 99 90

www.bjornhaug.no
bjorn@bjornhaug.no

